



SUBARU

PART NUMBER: E361SAJ400





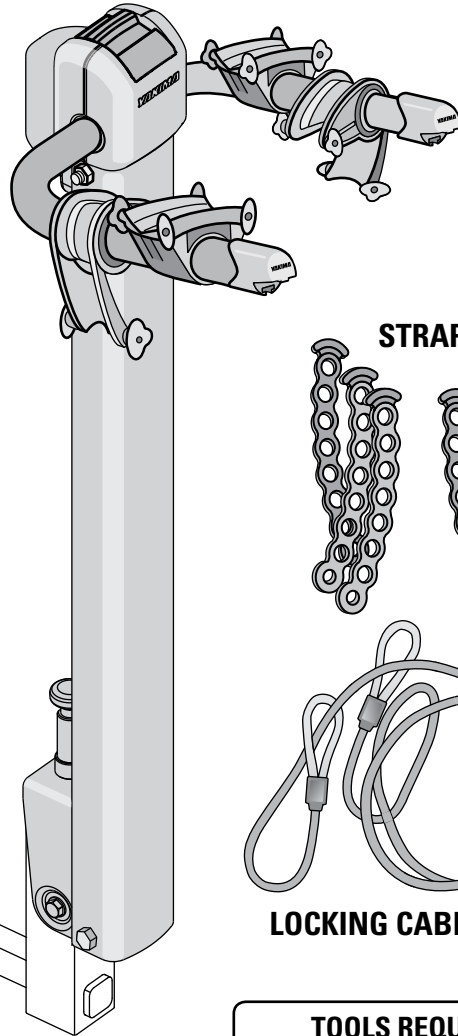

**INSTALLATION
INSTRUCTIONS**

DESCRIPTION: HITCH MOUNT 2 BIKE CARRIER

A KIT CONTENTS:

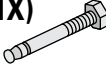

**DO NOT USE THIS PRODUCT
WITH HITCH EXTENDERS.**

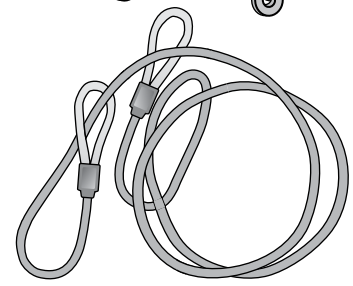
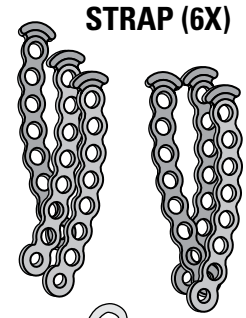

- PIVOT BOLT (1X)** 
- PIVOT WASHER (2X)** 
- PIVOT NUT (1X)** 
- HITCH BOLT (1X)** 
- LOCK WASHER (1X)** 
- WASHER(1X)** 
- SAFETY CLIP (1X)** 

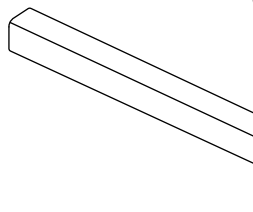
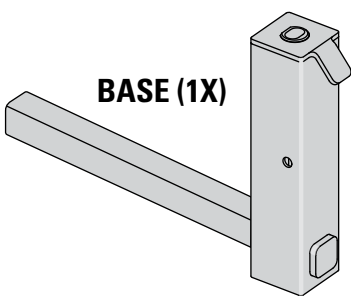

LOCKING CABLE (1X)



LADDER LOCK STRAP (4X)

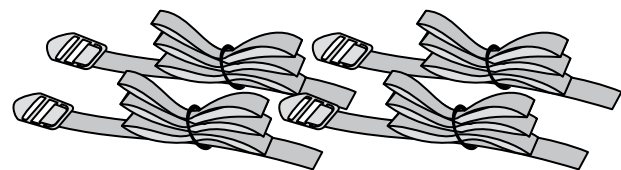

TOOLS REQUIRED:

- 3/4" WRENCH
- TWO 9/16" WRENCHES

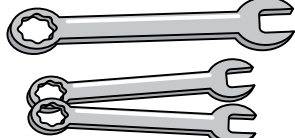

CAUTION: ATTACHMENT HARDWARE CAN LOOSEN OVER TIME. CHECK AND TIGHTEN IF NECESSARY, BEFORE EACH USE.

MAINTENANCE: USE NON-WATER SOLUBLE LUBRICANT ON BOLTS. USE A SOFT CLOTH WITH WATER AND MILD DETERGENT TO CLEAN PLASTIC PARTS.

THIS PRODUCT MAY OBSTRUCT VISIBILITY OF YOUR VEHICLE'S LICENSE PLATE. CHECK YOUR LOCAL & STATE LAWS REGARDING REAR LICENSE PLATE AND VISIBILITY OBSTRUCTION BEFORE USING THIS PRODUCT.

RETAIN THIS INSTRUCTION SHEET FOR FUTURE REFERENCE.

1033573 Rev. B



SUBARU

PART NUMBER: E361SAJ400

**INSTALLATION
INSTRUCTIONS**

DESCRIPTION: HITCH MOUNT 2 BIKE CARRIER

1 INSTALL TONGUE.

Push the tongue into the hitch plate, aligning the holes.

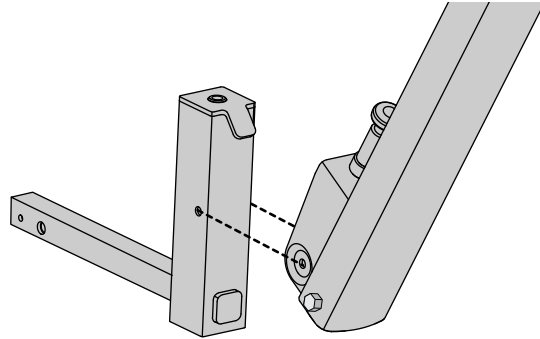

2

- Install hex bolt and a flat washer.
- Add a second washer, attach a nut.
- Tighten with firm pressure. If mast will not pivot once installed into the hitch receiver, slightly loosen nut.

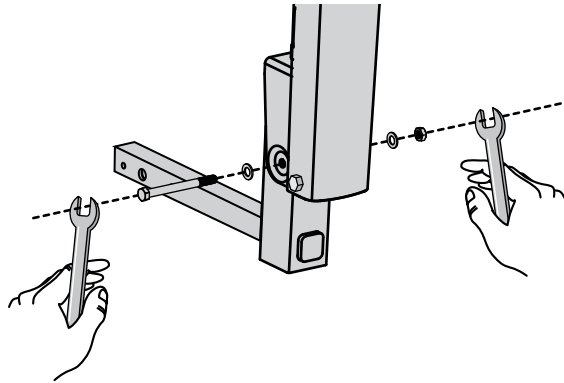

3

**INSERT TONGUE INTO
VEHICLE'S HITCH.**

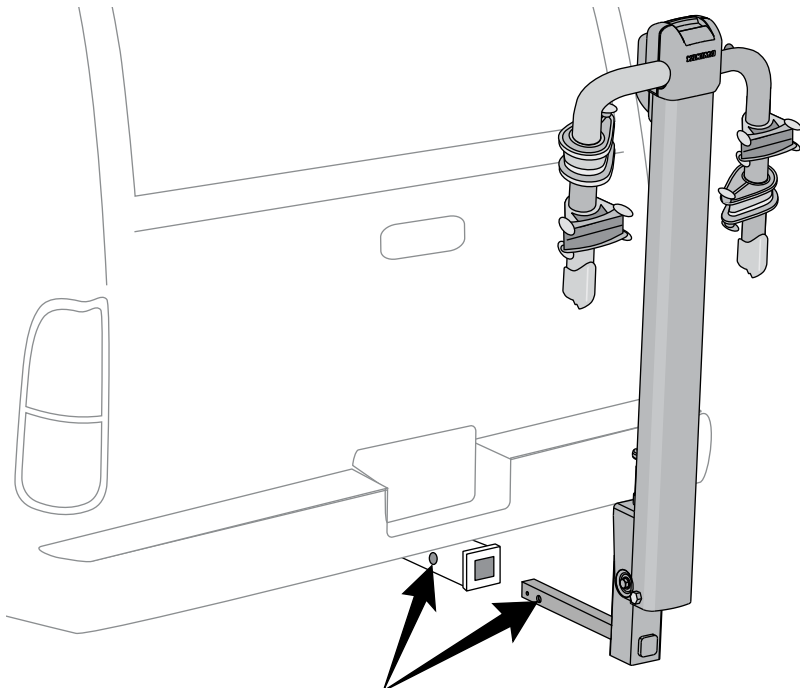

*Align the holes in the receiver
to the holes in the tongue.*



SUBARU

PART NUMBER: E361SAJ400

**INSTALLATION
INSTRUCTIONS**

DESCRIPTION: HITCH MOUNT 2 BIKE CARRIER

4 INSTALL LARGE BOLT, LOCK-WASHER, AND WASHER.

- *Install bolt, lock-washer, and washer from right side of receiver.*

- **Install safety pin.**

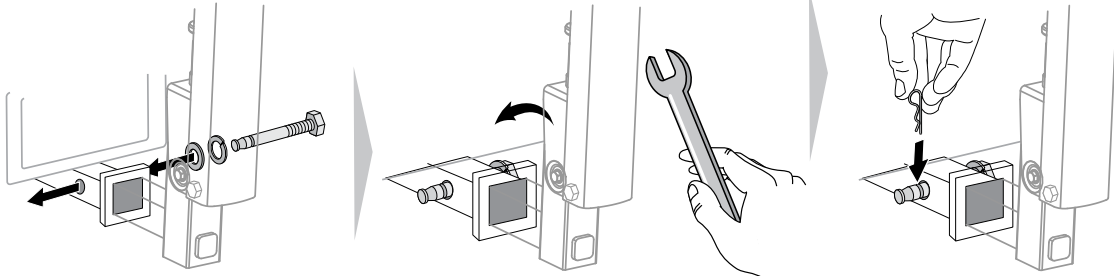

- **TIGHTEN** with wrench until fully tightened.

5 EXTEND ARMS.

Pull the lever to release the arms from down position.

CAUTION
Keep fingers away from ALL moving parts!

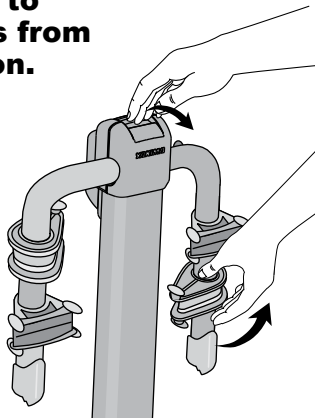

RAISE ARMS COMPLETELY.

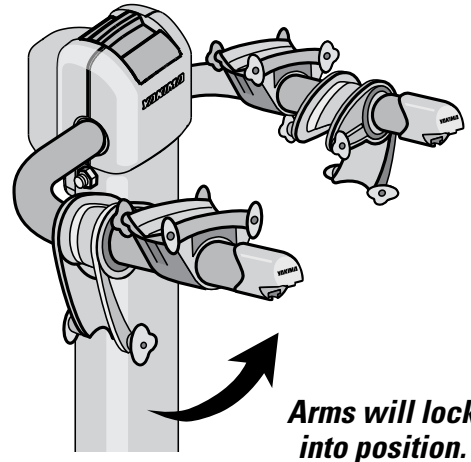

Arms will lock into position.

6 Attach one rubber strap to each cradle and stabilizer.

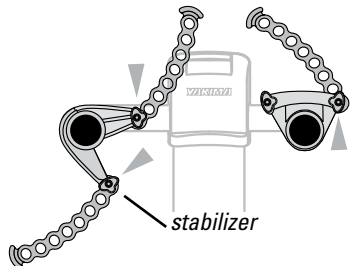
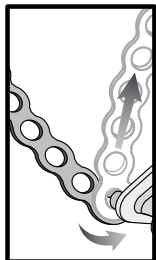

CRADLE POSITIONING

To slide cradles along the carrier arms, close cradle and stabilizer.

Close cradles while loading bikes.

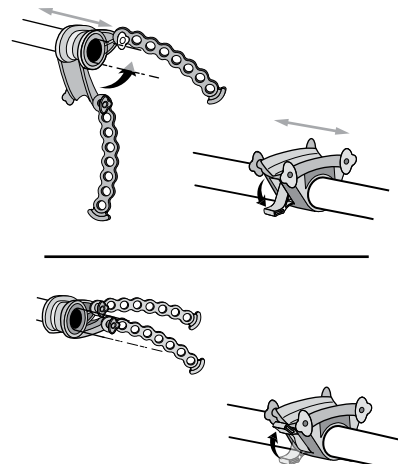



SUBARU

PART NUMBER: E361SAJ400

**INSTALLATION
INSTRUCTIONS**

DESCRIPTION: HITCH MOUNT 2 BIKE CARRIER

7 LOAD HEAVIEST BIKE FIRST.

- Always load first bike with chain away from vehicle.
- Compress cradles against stabilizer.



Always use the cradles closest to the vehicle.

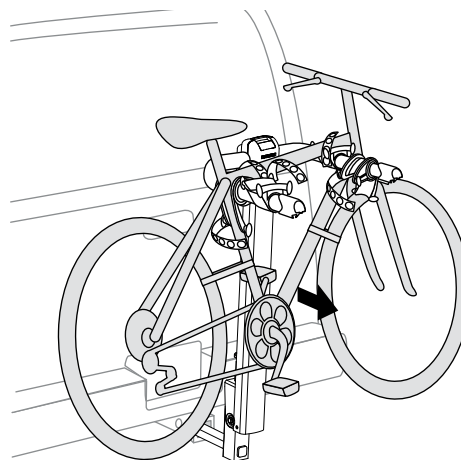

8 Stabilize the bike frame in the cradle.

Arrange bikes for best stabilization.

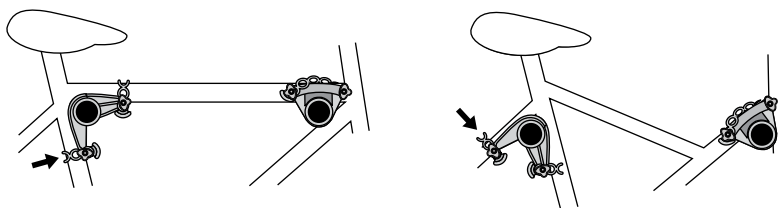

9 Pull straps tightly over frame diagonally, hook into place.

The straps can be routed under the cables.

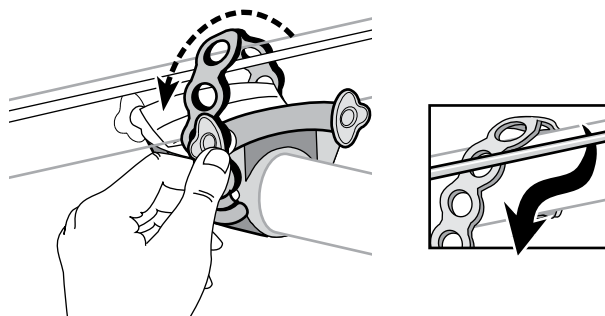

10 LOAD REMAINING BIKES.

Alternate bike directions to avoid interference.

Stabilize bike, secure with straps.

Install one ladder lock strap on each wheel & bike frame to prevent tire rotation.

Note: 6ft cable can be used to secure bikes to rack using the two loops, and a padlock (padlock not included).

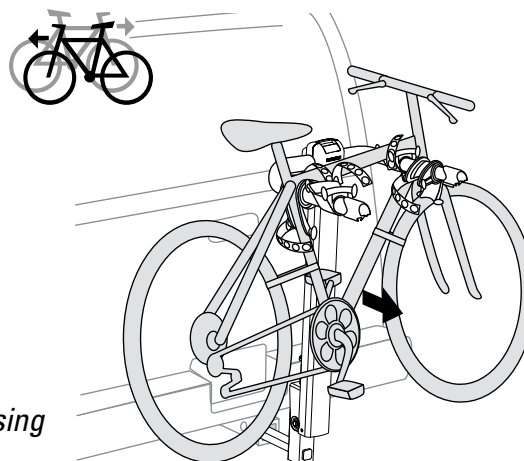



SUBARU

PART NUMBER: E361SAJ400

*INSTALLATION
INSTRUCTIONS*

DESCRIPTION: HITCH MOUNT 2 BIKE CARRIER

11 FOLD MAST DOWN TO ACCESS THE REAR:

- Unload the bikes.
- Pull release knob upward.
- Fold mast down.
- When finished be sure to bring mast back to the upright and locked position.



CAUTION: KEEP FINGERS AWAY FROM ALL MOVING PARTS!

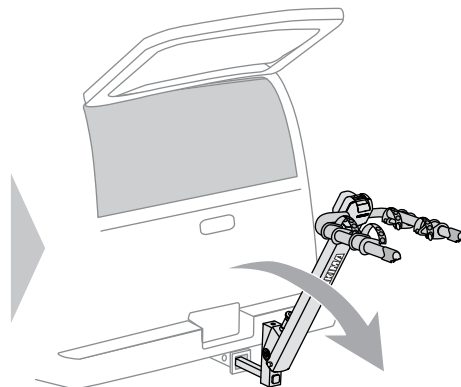
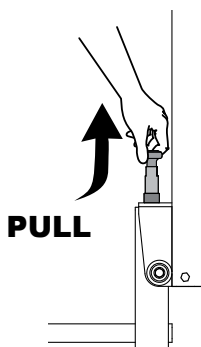

CAUTION: NEVER OPERATE VEHICLE WITH HITCH MOUNT IN FOLDED POSITION!

12 FOLD CARRIER ARMS WHEN NOT IN USE.

- Pull release lever forward.
- Pull up slightly on arms while pulling lever.
- Fold arms.

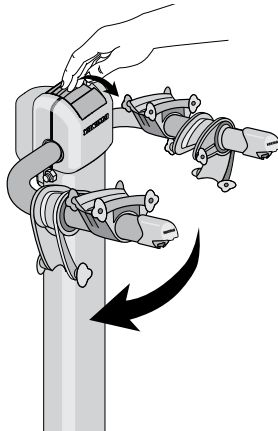

Be sure arms lock in down position.

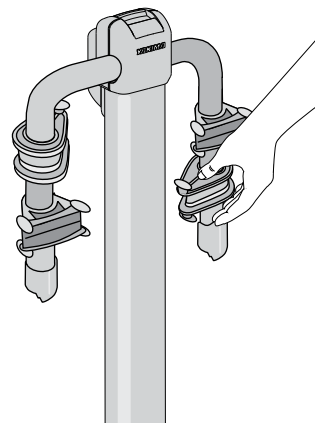

13 PERFORM SAFETY CHECKS

- Mast must be locked into place when operating vehicle.
- Be sure the straps are hooked securely over the bike frames.
- Replace straps if cracked or worn.
- Be sure all hardware is secured according to instructions.
- Do not let bicycle tires hang near vehicle's hot exhaust.



IF YOUR VEHICLE HAS A REAR HATCH:
On some vehicles, hatch interference is unavoidable. Use caution when opening your hatch.



SUBARU

PART NUMBER: E361SAJ400

*INSTALLATION
INSTRUCTIONS*

DESCRIPTION: HITCH MOUNT 2 BIKE CARRIER



***Mast must be locked
in place before loading
bikes or moving vehicle!***

CLICK

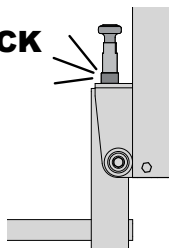

MAINTENANCE

Use non-water soluble lubricant on moving metal parts. Use a soft cloth with water and mild detergent to clean rubber parts.



IMPORTANT LOAD LIMITS

Total weight, 90 lbs./41kg

— USE —

- Off-road driving is not recommended and could result in damage to your vehicle, hitch receiver, or your bikes.
- Do not transport bicycles with attached baby seats, panniers, wheel covers, full bike covers or motors.
- Not intended for tandem, or recumbent bikes.

— INSTALLATION —

- Do not install on trailers, campers, or mobile homes.
- Remove this rack before entering an automatic car wash, and when not in use.

This product is designed for a hitch receiver, Class II or greater.

Some undersized receivers may not accept this product.

If you do not know the capabilities of your hitch receiver, consult an automotive professional.



WARNING

Attachment hardware can loosen over time. Check before each use, and tighten if necessary. Failure to perform safety checks can result in property damage, personal injury, or death.

KEEP THESE INSTRUCTIONS!